



**PRESSÃO**

**TEMPERATURA**

**NÍVEL**

**GÁS**

**VAZÃO**



desde 1977

**NAKA**

INDÚSTRIA E COMÉRCIO DE  
INSTRUMENTAÇÃO INDUSTRIAL

**ISO 9001:2000**

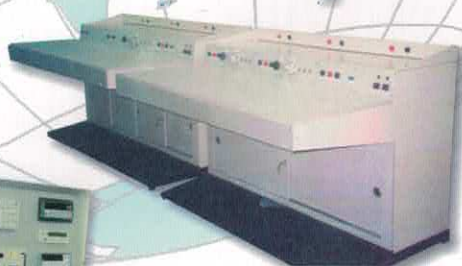
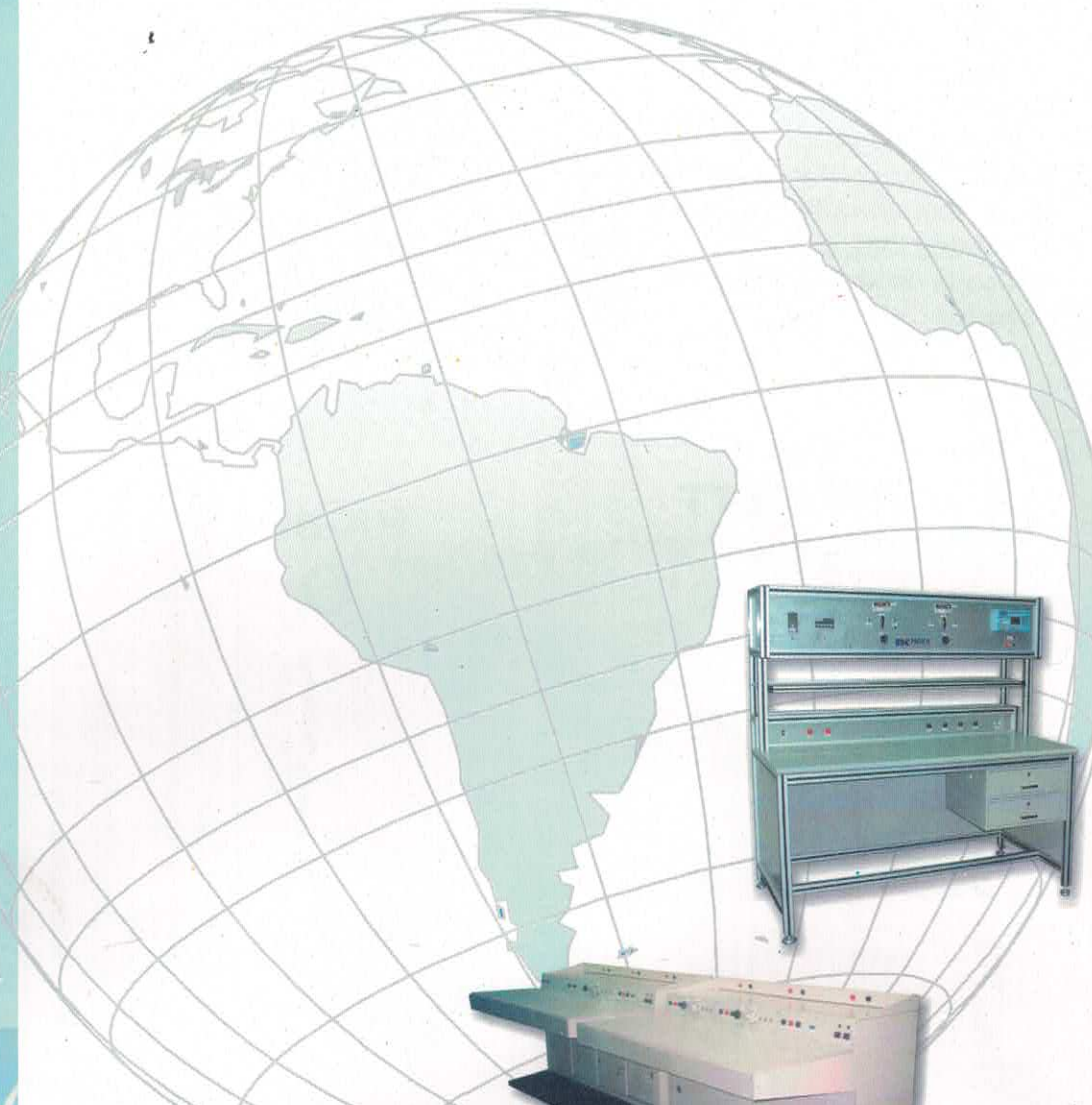

**Bancadas**

### DESCRIÇÃO GERAL E APLICAÇÃO

A NAKA está no mercado desde 1977, atuando no desenvolvimento e fornecimento de Bancadas de Teste.

As Bancadas NAKA são projetadas e desenvolvidas através de estudos e análise dentro da necessidade de cada cliente, adequado a cada tipo específico de aplicação.

Nossa vasta experiência na área de instrumentação e a grande variedade de modelos de bancadas nos permite apresentar a solução ideal para o seu caso específico.

### MODELOS

Bancada Eletropneumática

Bancada Elétrica

Bancada Eletrônica

Bancada de Enchimento Líquido

Bancada Banho Termostático

Bancadas Especiais

Bancada de Manutenção de

Válvulas

### NK-BEP



### NK-BEN



ENCHIMENTO LÍQUIDO

### NK-BETT

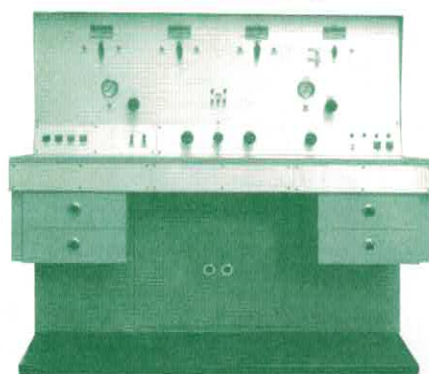

### NK-BBT



BANHO TERMOSTÁTICO

### NK-BET



### NK-BELE

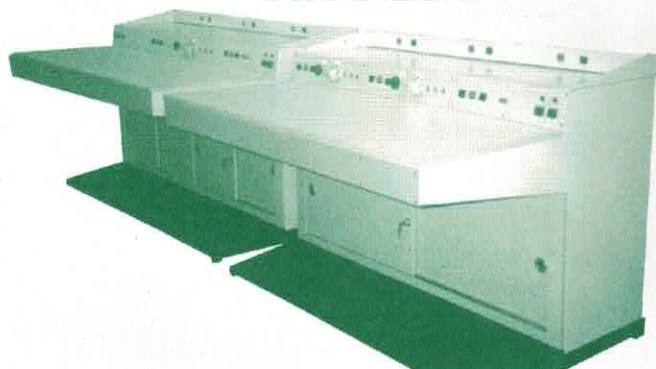

**ENCHIMENTO LÍQUIDO****NK-BEN**

C = 500, 1500, 2000 mm  
 A = 1430 mm  
 L = 980 mm

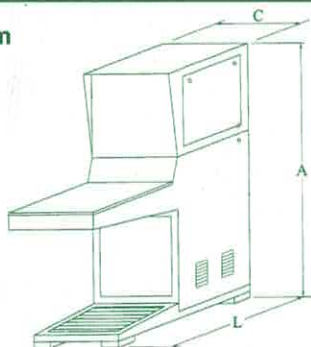
**NK-BEN****BANHO TERMOSTÁTICO**

C = 500, 1000, 1500, 2000 mm  
 A = 1430 mm  
 L = 980 mm

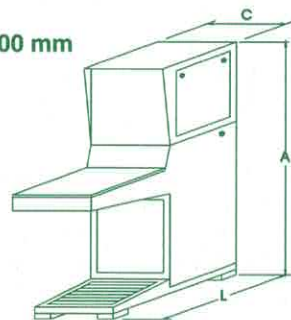
**NK-BETT**

C = 500, 1000, 1500, 2000mm  
 A = 1380 mm  
 L = 980 mm

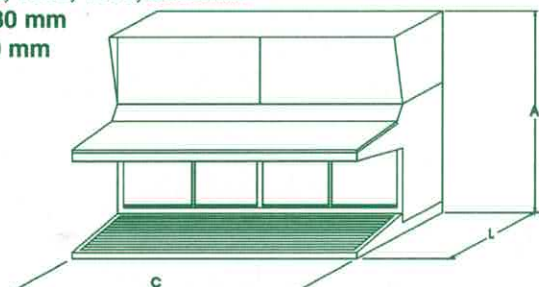
**NK-BEP**

C = 1200, 1600, 1800, 2000 mm  
 AM = 830 mm  
 AT = 1650 mm  
 L = 850 mm

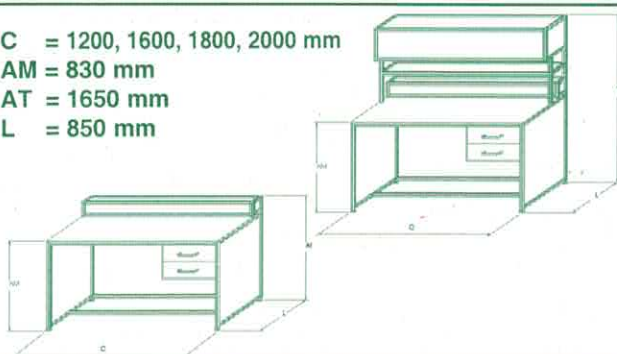
**NK-BET**

C = 500, 1000, 1500, 2000 mm  
 A = 1380 mm  
 L = 980 mm

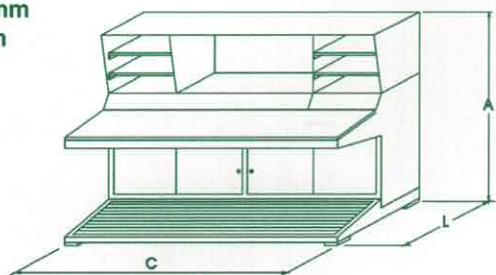
**NK-BELE**

C = 500, 1000, 1500, 2000 mm  
 A = 930 mm  
 L = 980 mm

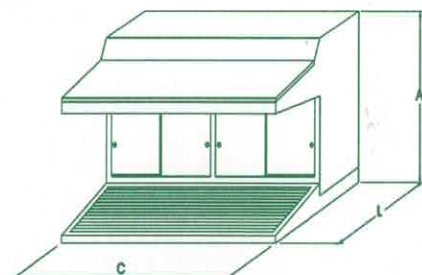
**NK-BS**

C = 1500, 2000 mm  
 A = 700 mm  
 L = 1500 mm

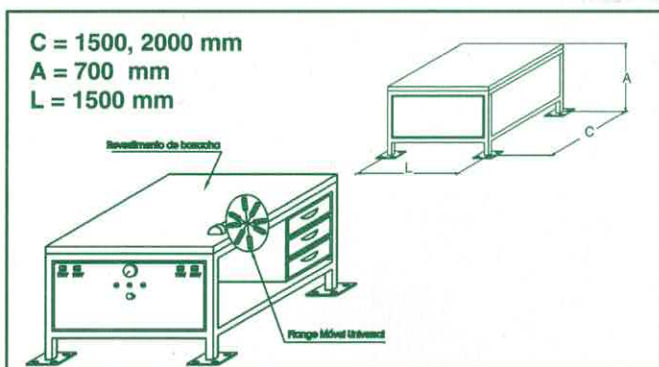
**ESPECIAIS**

C = 500, 1500, 2000 mm  
 A = 930 mm  
 L = 980 mm

